

Profec Kugelhahn PVC-U 20 mm Klebemuffe 16bar DN15 Grau Typ Safe 600 (0112101)



ABMESSUNGEN

Lb 84 mm

ØDi-1 20 mm

ØDi-2 20 mm

Ct-1 46 mm

R 35 mm

ØDf 15 mm

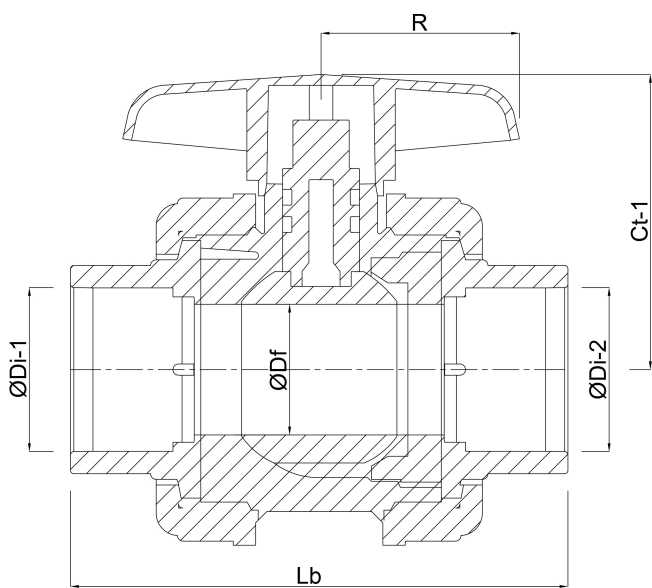

PRODUKTINFORMATIONEN

Mit gesicherter Kugel.

Generiert am: 30.10.2025

bevo Vertriebs GmbH
Industriestraße 18
32602 VLOTHO-EXTER
Deutschland
+49 (0) 5228 959 0
info@bevo.com
<http://www.bevo.com>