

Profec Nr. 3 Bogen 90°
Edelstahl 316 3/8"
Außengewinde 10bar
(0080762)



TECHNISCHE DATEN

Werkstoff	Edelstahl 316
Anschluss	Außengewinde
Fitting Nr.	Nr. 3
Arbeitsdruck	10 bar
Maß	3/8"

ABMESSUNGEN

$\varnothing D_{o-1}$	3/8 "
$\varnothing D_{o-2}$	3/8 "
Cb-1	70 mm
Cb-2	70 mm
β	90 °

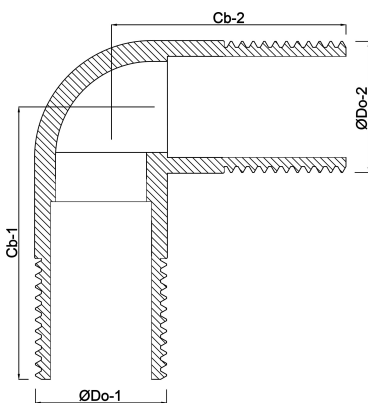

Generiert am: 23.10.2025

bevo Vertriebs GmbH
Industriestraße 18
32602 VLOTHO-EXTER
Deutschland
+49 (0) 5228 959 0
info@bevo.com
<http://www.bevo.com>